



FINER Details

# WHY CHOOSE TRICEPT



This feature guide has been designed to help you fully understand the numerous benefits included with the Tricept range of products.

The success of the Tricept brand is largely down to the many features patented and unique to Tricept that enhance both your security and home energy savings.

Hopefully the information contained in this manual along with the Tricept Design Guides will help you make an informed choice when selecting the right products for your home.

## contents

Why Choose Tricept	Pg 2
Energy Rated Windows	Pg 3
The Intelligent System	Pg 6
Tricept Window Security	Pg 8
Tricept Door Security	Pg 9
Quality Assurance	Pg 10
Accurate Installation	Pg 11

## Recognising our environmental responsibility together

We acknowledge our responsibility to the environment and believe that energy ratings are essential in helping you to make an informed decision when purchasing new windows and doors.

## So what are energy ratings?



If you are considering the replacement of your windows and doors then you will probably have been inundated with information and instructions on how you, the consumer should take more responsibility in choosing the most energy efficient products for your home.

In the past you may have encountered energy ratings when purchasing other household products such as washing machines, freezers, refrigerators and light bulbs.

The Government have committed to reduce the levels of carbon dioxide emissions. **They have put controls in place to reduce the energy loss of domestic dwellings because window heat loss can account for up to 30% of the total heat loss from a house.**

Therefore replacement windows are now energy rated which will keep your heating bills down and help reduce harmful CO<sup>2</sup> emissions.

## Understand how energy saving windows work

Window manufacturers supply the British Fenestration Rating Council with accurate drawings of the window sections along with details of the type of glass sealed units used.

Computerised simulation tests are then carried out that will assess:

- 1) Solar Heat Gain.
- 2) Thermal Losses.
- 3) Air Losses.

Based on these results all windows are then certified from an 'A' Rating to 'G' Rating ('A' being the best possible energy saving performance window).

Modern glass technology offers a range of glass types that together with new warm edged spacer bars and argon gas cavity infill, help achieve lower U-values and provide a far more energy efficient window.



Therefore replacement windows are now energy rated which will keep your heating bills down and help reduce harmful CO2 emissions.

### Solar heat gain (Positive)

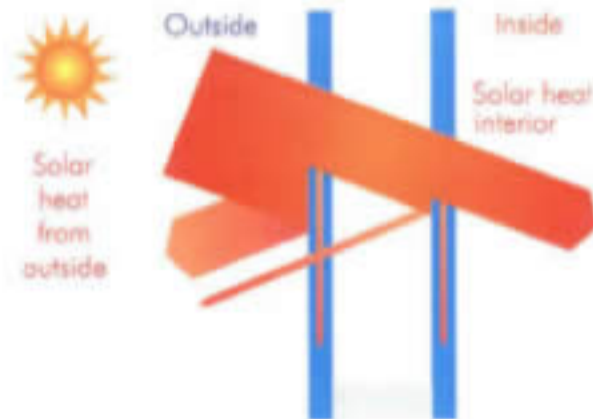

Solar heat is reflected, absorbed and transmitted

### Thermal losses (Negative)

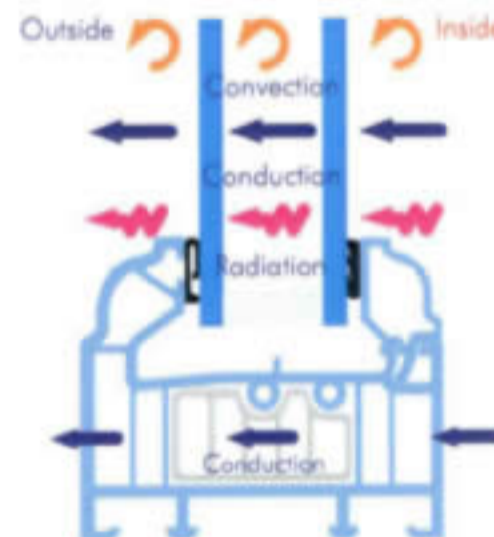

Thermal losses from convection, conduction and radiation

### Air losses (Negative)

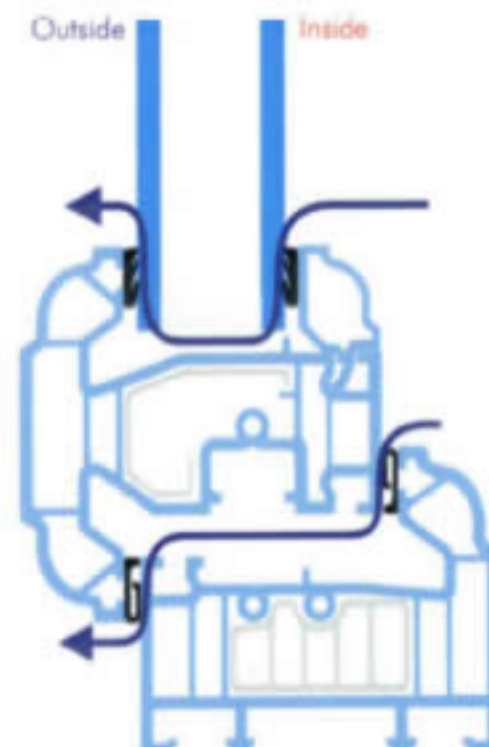

warm air leaks out through the window

EXTERNAL GLASS



## Why choose Tricept?

Tricept windows were tested for their energy efficiency using a variety of glass sealed unit configurations. The tests concluded that Tricept Bevelled and Ovolo systems achieved similar results and were awarded 'C', 'B' and 'A' ratings with an Energy Index far higher than many of its competitors, surpassing the standards of all current building regulation requirements.

INTERNAL GLASS

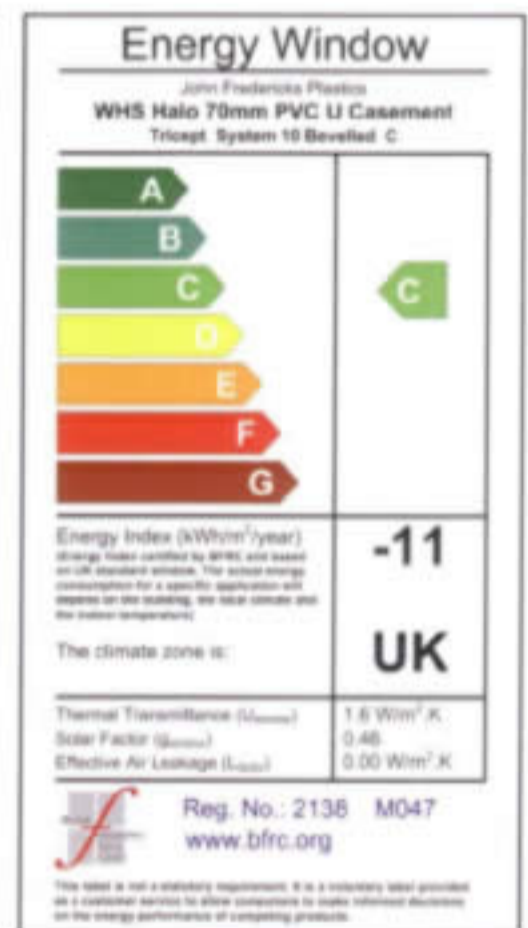
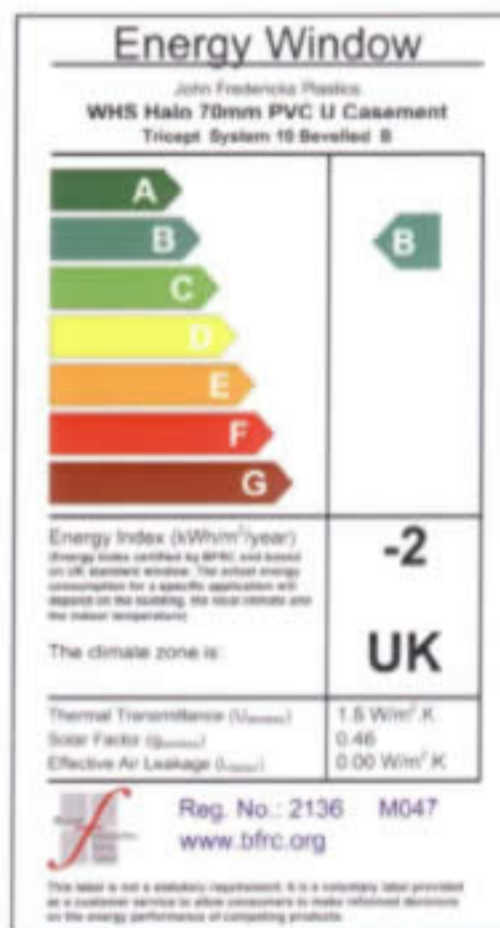
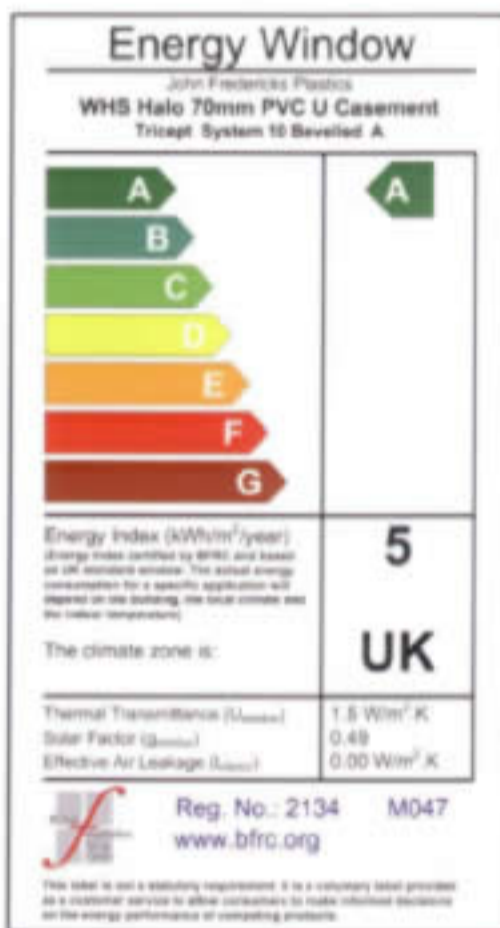

### The Genuine article

All Tricept PVC-u windows and sealed units are manufactured to the highest specification and assembled in-house, this guarantees that the standard for the energy rating you have requested has been met.

The red glow shown on the internal face of the entire window area symbolises the amount of heat Tricept windows retain. As a result, the inside of your property remains warmer and more energy efficient.



The BFRG confirm that Tricept Energy Windows are 67% more efficient than conventional double glazed PVC-u windows.

# THE INTELLIGENT SYSTEM

## Thermal Enhancement

To maximise thermal performance new Tricept is engineered from 70mm wide profile (the industry maximum). Innovative outer frame thermal PVC-u reinforcing ensures optimum energy efficiency with a minimum of 7 vertical chambers helping to resist outside temperatures and retain the internal warmth.

**This new technology results in far greater heat retention and continues to meet all the requirements achieved by conventional hollow metal reinforcing.**

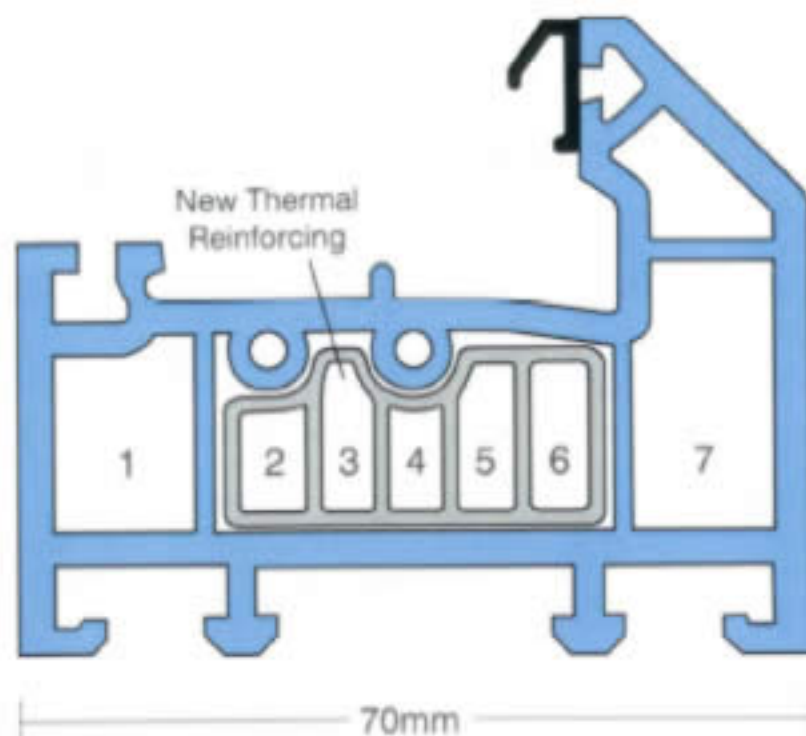

## Top Grade PVC-U

European Committee standards state that Grade A PVC-U must have an outside wall thickness of at least 2.8mm.

Tricept wall thickness is 3mm which offers superb frame strength and rigidity that will last for years.

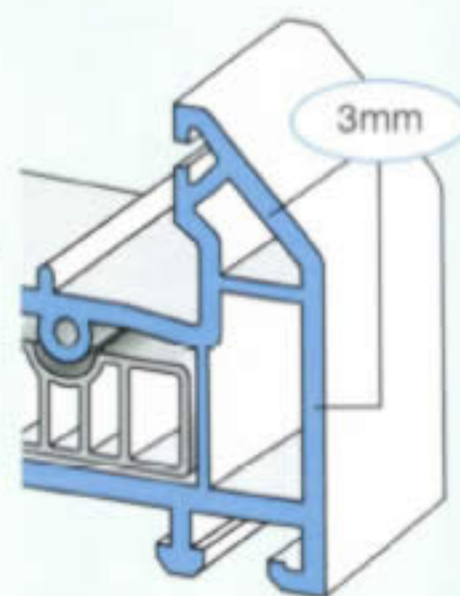

## Weather Resistance

You should expect your new windows and doors to be completely draught proof and water tight. New Tricept is produced with all weather compression gaskets, fused to both the inner and outer frame sections. The gaskets include a 9mm 'flipper seal and backing cushion' to ensure ultimate weather resistance and sealed unit stability. The flipper seal remains inline with the profile for a neater appearance and because they are fused to the profile they can never shrink back thus avoiding any leaks or irritating draughts in your home.

## Integral Drainage

To enhance the weather resistance further Tricept has a sophisticated 'built in' sloping drainage system that directs any water penetration away and towards the external drainage route.

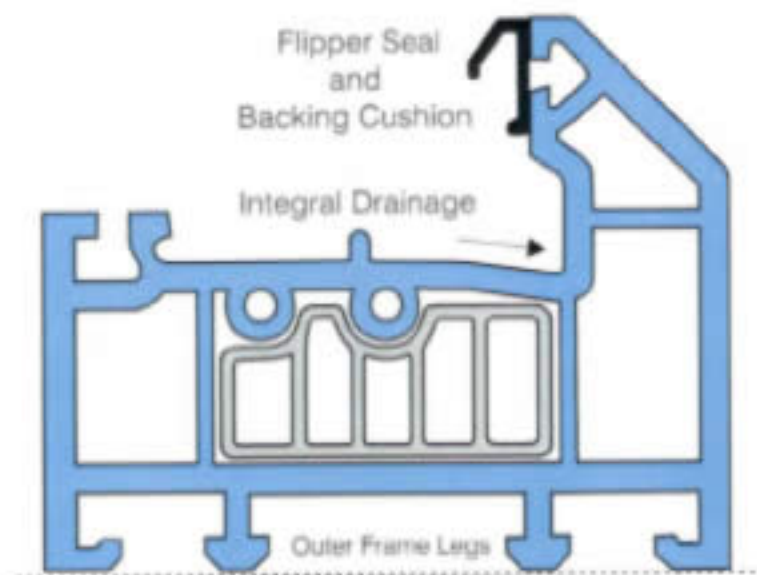

## Neat Installations

To ensure your windows are fitted neat and square, and to prevent 'bowing' upon installation, two 8mm legs have been added to the brick facing edge of the profile to provide a solid fixing.

# THE INTELLIGENT SYSTEM

## Correct Glazing

In order to avoid the breakdown of glazed units it is essential that your unit remains in dry conditions at all times.

Tricept have designed a unique glazing packer (1) that is sprung in place for the glazed unit (2) to sit on and therefore create a bridge between the sealed unit and any water or dampness, thus preventing condensation forming inside your units.



## Versatility

Whilst all the profiles remain technically the same, Tricept offer you a choice of either a fully bevelled system or fully ovolo depending on your preference.

## Clean Lines

Both systems have been designed to be symmetrically correct in that all flat surfaces are similar in width which in essence offers a far slimmer and more aesthetically pleasing appearance to your window.



Bevelled Design



Ovolo Design

## smart safety solutions

For your safety, easy clean / fire escape hinges are fitted as standard to all side-opening windows. These windows open to a full 90° for means of fire escape and can be pulled across to gain access to the outer glass for ease of cleaning.



# TRICEPT WINDOW SECURITY



Fitted with the unique Tricept 9 point locking system you can feel safe and secure in your home knowing that every opening window is secured on all 4 sides.

## Security Handle

- Locks automatically on closing
- Simple push button release
- Additional key locking as standard
- Modern stylish design
- Concealed screw fixings



The Tricept 9 point locking system includes

2 x 8mm High Strength Brass Shoot-bolts.

2 x 3mm stainless steel hinge locks and 4 x 8mm IXEF Dog-bolts.

1 x 5mm x 22mm Steel Dead Lock operated by the stylish push button key locking handle.

## Neat Ideas

To enhance the appearance of your new windows, Tricept designers have created superb white IXEF keeps to accommodate all window locks.

IXEF is the hardened material used in 'crash helmet' technology.

It is stronger than brass, colour-coded to match each window and will not show scratches or similar.



# TRICEPT DOOR SECURITY

In December 2007 The British Standards Institute revised entrance door lock testing to combat a number of weaknesses identified with key cylinders.

For your ultimate security every Tricept door is now fitted with a unique cylinder-free multipoint lock system designed exclusively to fit both entrance doors and french doors.

The Tricept lock system includes top and bottom shoot-bolts, 3 outer/inner facing hook locks and a centre locking latch. In addition 4 roller cams add to the security whilst ensuring maximum weather seal.



## Smooth operation

To ensure a smooth operation all of the ten locking mechanisms are thrown simply by lifting the handle upwards and then key locked in the fixed position. French doors will include shoot bolts to the slave door that once again lock by lifting the slave door handle.

## All round security

To complete the all round security all Tricept doors are fitted with 3 high security, profile related hinges. Each hinge is secured using 11 fixings and incorporates a unique anti-jemmy claw for your ultimate protection.

Secured on all 4 sides, you can feel safe in the knowledge that Tricept doors come complete with a total of 13 security locking points.



feel safe, feel secure



User friendly mortice key with optional push-button key fob for that extra 'TRICEPT' touch of class.

# QUALITY ASSURANCE

The British Standards Kitemark is one of the most well known and respected product certification marks in the world and is your reassurance that BSI has checked that your Tricept PVC-u windows and doors comply with the latest British Standards.



FM 33147

## Quality Assurance ISO 9001:2000

This certification was awarded for providing a high level of Quality Control systems throughout manufacture, administration, health & safety, and products including that of our suppliers such as profile and hardware. We are required to give BSI unrestricted access to our offices and factories and allow random samples to be selected for testing on a regular basis.



KM 36014

## BS7412. PVC-U Windows

A primary standard for PVC-u windows whereby a series of mechanical and manual tests are carried out to ensure windows against weather performance, durability and an accepted level of burglar resistance.



KM 36015

## BS7950. PVC-U Windows - Enhanced Security

An enhanced security test whereby all elements and fittings were tested against forced entry and leverage to ensure ultimate window security.

## PAS23/24. PVC-U Doors (Compliant)

A primary and enhanced performance requirement for single PVC-u entrance doors. All elements of product were tested against weather tightness, operation, strength and cycle and all individual security features and assemblies.



KM 21528  
KM 73463

## BS EN1279 PT2. Sealed Units

A thorough and daily test routine for double glazed sealed units is carried out to ensure we maintain certification. Tests prove our sealed units adhere to correct dew point, sealant correctness, desiccant moisture absorbency and solar properties of the specified glass.

## The British Board of Agrément

A Government partnered organisation to provide authoritative information on the performance of building products. To gain accreditation, Tricept products were assessed in 3 separate areas: laboratory testing, site inspections and factory production control. Rigorous testing included air permeability, water tightness, effect of wind loads, thermal efficiency, durability of fittings, resistance to impact, racking and bending and ease of operation.

In addition all Tricept suppliers are accredited to ISO9001 Quality Assurance. Indeed our major profile, hardware and glass suppliers hold numerous other accreditations relative to their products: Including BS EN 12608:2003 standard for PVC-U Profiles, Secured By Design certification and corrosion resistance.

*With so many  
accreditations you can  
feel safe and secure in your  
home and comfortable with  
your investment in Tricept  
energy rated PVC-u  
windows and doors.*



## Clean and accurate installations

Naturally, you want to be assured that the quality of installation will match the quality of the products. As a Fensa registered company we work within an agreed code of practice that includes a full understanding of building regulations and all other Fensa requirements.

Prior to your installation, a full and accurate survey will be carried out. This survey ensures that your favoured style of windows or doors will blend sympathetically with your home.

All selected Tricept installers also work to a manufacturers code of best practice in order to achieve the highest level of consistent workmanship and service.

The areas outlined in our installation code of best practice include:

Professionalism  
Conduct & Work Ethics  
Communication  
Health and Safety

## What is Fensa?

Fensa stands for the Fenestration Self-Assessment Scheme. It was set up at the request of the Office of the Deputy Prime Minister to ensure that anyone who installs replacement windows or doors complies with current thermal performance and safety standards. The reason for this is to reduce energy loss in line with government policy.

When having windows and doors replaced homeowners must ensure that they get a certificate of compliance. This will be organised upon completion by your Fensa registered installer. Indeed, upon selling your property your solicitor will ask for this certificate as proof of compliance.



**FENSA**



**starlight**  
W·I·N·D·O·W·S·A·N·D  
C·O·N·S·E·R·V·A·T·O·R·I·E·S  
[www.starlightwindows.co.uk](http://www.starlightwindows.co.uk)

Starlight House, Leaside North  
Aycliffe Industrial Park  
Newton Aycliffe  
Co. Durham DL5 6DU

**Tel: 01325 321301**  
[sales@starlightwindows.co.uk](mailto:sales@starlightwindows.co.uk)